

micromagic systems

Animatronic & Puppet control systems for Film & Television

p.Brain-HexEngine V1.21 (Updated 12/10/09) **Configuration Guide**

Page 1 of 35

Contents

- (2) [Description](#)
- (2) [Key Features](#)
- (2) [Port Configuration](#)
- (3) [Terminal Connection](#)
- (4) [Boot Screen](#)
- (5) [Hexapod \(POD\) Geometry](#)
- (6) [Main Menu](#)
- (6) [Main Menu Commands Table](#)
- (7) [Main Menu Commands](#)
- (10) [Configuration Menu](#)
- (11) [Configuration Menu Commands Table](#)
- (14) [Configuration Menu Commands](#)
- (14) [P.Brain Configuration](#)
- (15) [Geometry Configuration](#)
- (18) [Gait Configuration](#)
- (20) [Servo Configuration](#)
- (26) [Behavioural Configuration](#)
- (27) [Body Motion Configuration](#)
- (28) [Head Configuration](#)
- (30) [ESD200 Bluetooth Configuration SMB](#)
- (32) [ESD200 Bluetooth Configuration \$\mu\$ 24](#)
- (33) [PS2 Gamepad Control](#)
- (35) [Legal](#) (Please Read First)



p.Brain-ds24 HexEngine
(Requires p.Brain-SMB)



p.Brain- μ 24 HexEngine

p.Brain-HexEngine (V1.2) Configuration Guide

Description

The *HexEngine* is a software module designed for the *p.Brain-ds24* or *p.Brain-μ24* hardware modules. The *HexEngine* is a user configurable locomotion engine for hexapod robots. *HexEngine* is configured via a serial port (RS-232 or TTL level) using standard terminal software such as HyperTerminal or TerraTerm (As HyperTerminal is no longer included with Vista, I recommend using TeraTerm Pro available here: [TeraTerm Pro V2.3](#)). Once the *HexEngine* is configured for the target hexapod platform, the hexapod locomotion can be controlled using simple direction commands over either the RS-232 or TTL serial port. The idea of the *HexEngine* is to allow you to get your hexapod up and running with minimum fuss, allowing you to concentrate on obstacle avoidance or other high level control applications.

Key Features

- Configuration via terminal port or control port via optional blue tooth link
- Locomotion control via terminal port or control port
- Configurable body geometry
- Configurable leg geometry
- Multiple Servo output re-map configurations
- Gait configurations
- X,Y,Z Body rotation and translation
- Walk in any direction
- Servo rotation calibration
- Servo reverse for each leg joint
- Leg calibration offsets
- Four selectable gaits patterns (can be changed during locomotion)
- Two selectable leg move styles, giving a total of eight individual gaits.
- Eight supported baud rates
- Three PWM servo ranges, standard, extended and full (500 to 2500uS)
- Dedicated PWM hardware for precision 1uS PWM resolution

Port Configuration – (p.Brain-ds24)

There are two serial ports on the *p.Brain-ds24* which are used for locomotion control and/or terminal configuration. Using jumpers JP1 and JP2 on CN18 of the *p.Brain-SMB* there are four possible combinations for port configuration:

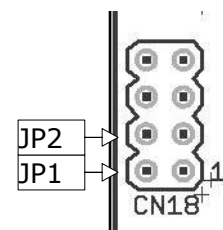

	JP2	JP1	UART1 TTL	UART2 RS232
1	OFF	OFF	Locomotion port	Configuration port
2	OFF	ON		Locomotion & Configuration port
3	ON	OFF	Locomotion & Configuration port	
4	ON	ON	Configuration Port	Locomotion Port

The baud rate for the TTL port is set by 'CBR' and the RS-232 baud is set by 'TBR' within the configuration menu. The default baud rates are: TTL port 9.6kbps, RS-232 port 115.2kbps.

Note: All port communications are 8 bit, No Parity, 1 Stop bit (8N1)

p.Brain-HexEngine (V1.2) Configuration Guide

Port Configuration – (p.Brain- μ 24)

There are two serial ports on the *p.Brain- μ 24* which are used for locomotion control and/or terminal configuration. UART2 is an TTL serial port which can be used for locomotion control only. UART1 is connected to either the RS-232 RJ11 port or the optional ESD200 bluetooth adaptor using JP1. This port defaults to PIP locomotion control mode, but can also be used for the hexapod configuration mode / terminal port.

Terminal Connection

In order to configure your *HexEngine*, you will require terminal software such as HyperTerm or Tera Term, a free serial port and a suitable RS232 lead. If you are using the *p.Brain-SMB* in conjunction with the *p.Brain-ds24* or the *p.Brain- μ 24*, there is an RJ11 4/4 to DB9 RS232 cable available from micromagic systems (MSR-RJ11-232). If you wish to make your own cable you will need to use the following connections:

RJ11 4/4 Connector	DB9 Female Connector	Description
1	3	RS232 RX
2	2	RS232 TX
3	5	GND
4		Unused

p.Brain-RJ232

Micromagic systems RS-232 DB9 to RJ11 serial port adaptor.

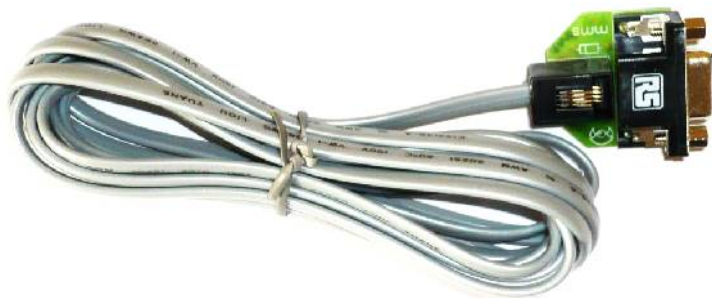

p.Brain-ds24:

It is also possible to configure the *HexEngine* via UART1's TTL interface, in order to do this you will require a suitable TTL interface converter to your host system or a blue tooth module such as the ESD200 connected to UART1. If you are using the *p.Brain-SMB* PCB, there is a suitable socket for the ESD200, please see the p.Brain-SMB user guide for installation guidance.

p.Brain- μ 24:

It is possible to configure the *HexEngine* using either the RS-232 interface, the ESD200 bluetooth adaptor, or a TTL compatible serial port using the ESD200 socket. See the *p.Brain- μ 24* user guide for ESD200 installation and configuration.

p.Brain-HexEngine (V1.2) Configuration Guide

Boot Screen

```

Tera Term - COM1 VT
File Edit Setup Control Window Help
p.Brain-HexEngine <c> - micromagic systems ltd   STATUS   ERROR   TITLE
U0.1 - Jul 27 2008                               OFF            MAIN
>
Type '?' For a list of available commands.
TERMINAL port == CONTROL port, type 'CONTROL' to enter control mode.
Engine Running @ 50.00 FPS
EEPROM Size : 8191
Compiler V9.60 PL3
MIN PWM = 800 uS, MAX PWM = 2200 uS
Initialising Pod..
Pod Configuration File Read OK. 174 bytes
Initialising Legs..
Loading Calibrbtion data. OK.

```

Upon boot, you should see a boot screen similar to the one above. At the top is the title bar, which displays software name and version, hexapod status, error codes and page title. Upon boot various information is listed such as the frame rate, EEPROM size, PWM range and compiler version.

The *HexEngine* will also load the Pod (short for hexapod) configuration file and Pod calibration file. If there is a problem with either of these files you will be informed during boot. The configuration file holds all the geometry, gait and default boot values for the pod. If this is the first time the *HexEngine* has been run, it will have loaded up with a default set of geometry values, so the first thing to do is to enter the configuration menu.

If you are using a *p.Brain-μ24*, to enter configuration mode type "@@@", do not type any other key for at least one second. (To exit configuration mode, return to the MAIN menu and type "PIP Control" followed by the ENTER key.

Type '?' followed by the ENTER key to see a list of commands for this menu screen.

p.Brain-HexEngine (V1.2) Configuration Guide

Hexapod (Pod) Geometry

Before you start configuring your hexapod, take time to study the following drawings to help you understand the basic geometry of a hexapod. *Note: print this out and keep it handy.*

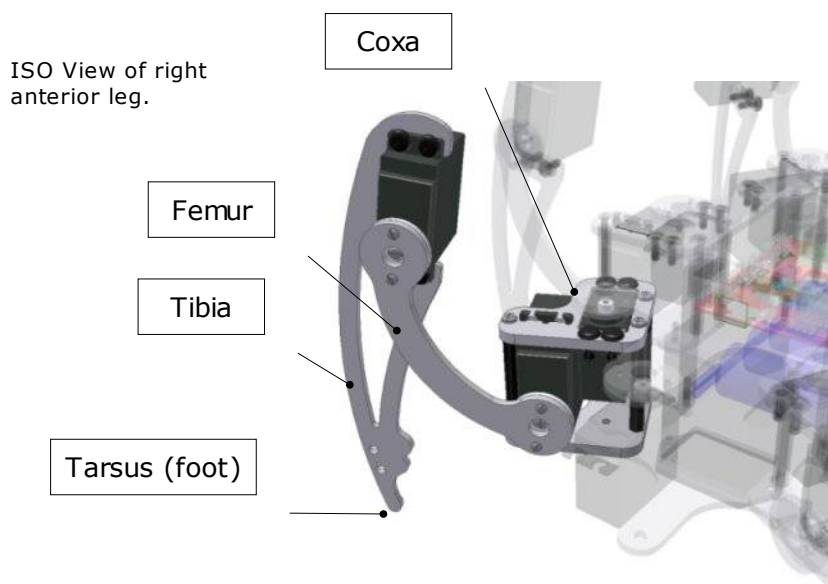
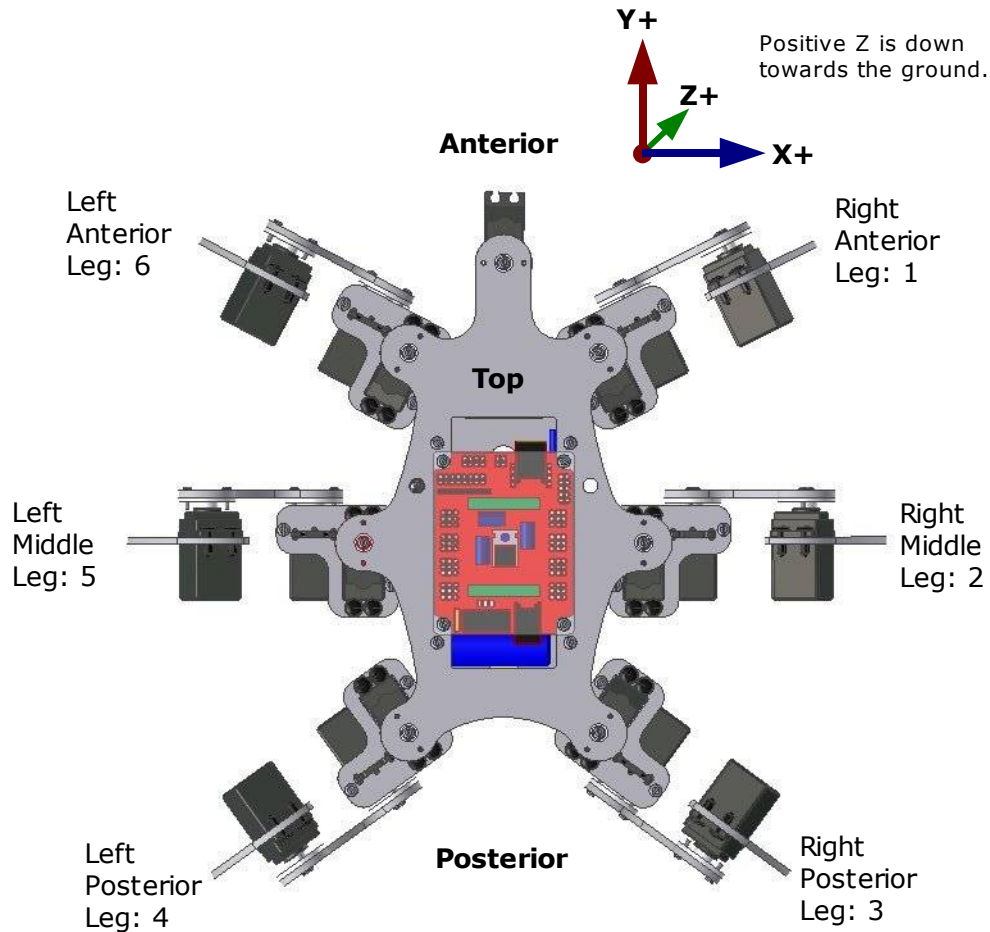

p.Brain-HexEngine (V1.2) Configuration Guide

Main Menu

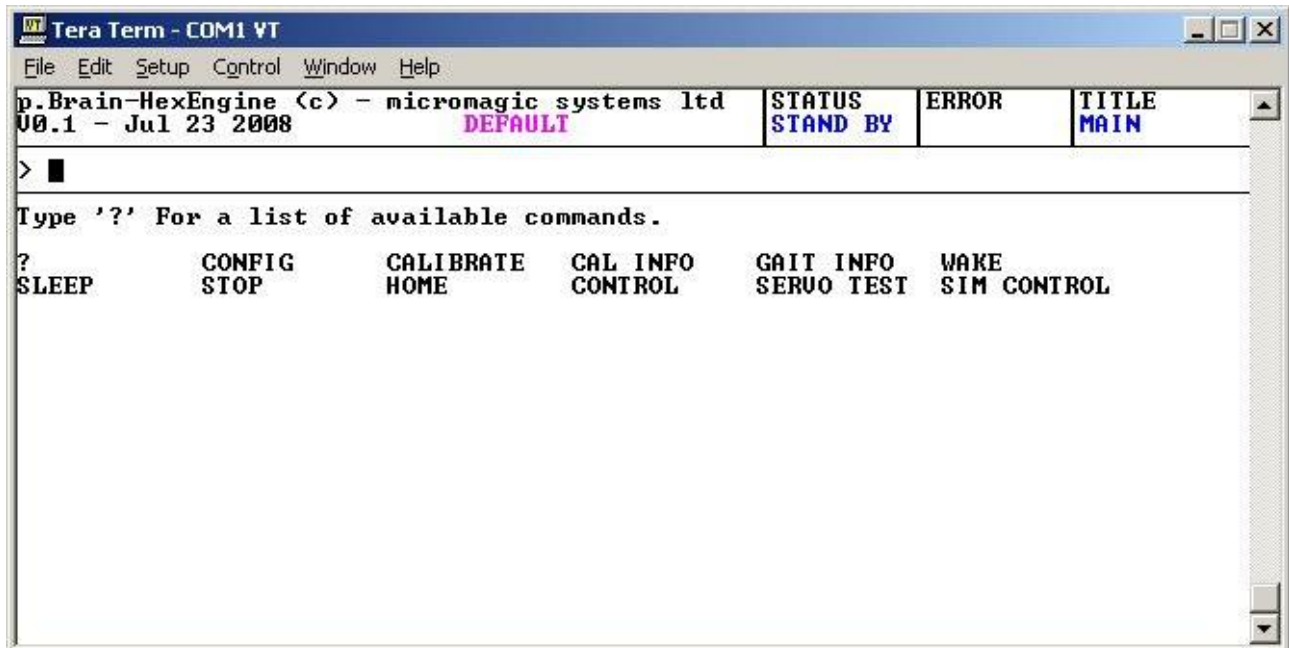

After the initial boot message the hexapod is ready for locomotion control or one of the commands listed in the main menu. Locomotion control only works within the main menu and the gait info screen, if the hexapod is powered up and one of the configuration screens is entered such as 'CONFIG' the hexapod will power down.

Main Menu Commands Table

Command	Description
?	List all available commands within this screen
CONFIG	Enter configuration screen
CALIBRATE	Enter servo calibration screen
CAL INFO	Display calibration data
LEG INFO	Display tarsus position and leg angles
GAIT INFO	Enter gait information screen
WAKE	Wake the hexapod
SLEEP	Hexapod into standby
STOP	Stop the Hexapod
HOME	Reset Hexapod legs to home position
SERVO TEST	Enter servo test screen
PIP CONTROL	Enter (Packet Interface Protocol) locomotion control mode
SIM CONTROL	Enter Simple locomotion control mode
PORT TEST	Enter I/O port test screen
PS2 TEST	View PS2 Gamepad connection status and values

p.Brain-HexEngine (V1.2) Configuration Guide

Main Menu Commands

Calibrate

In this screen the servo calibration offsets can be set for each leg joint. Servo calibration offset can be between -127 to 127 uS. Before beginning calibration, it is best to move your hexapod legs into the approximate calibration position, and to stand your hexapod off of the ground so that none of the legs come in contact with the floor. **Be prepared for sudden servo moves. Also if your configuration file is not set-up correctly servos may drive into the body or other legs, so always be ready to stop the servo refresh with the '-' key or switch off the servo power.**

Calibration Position Diagram

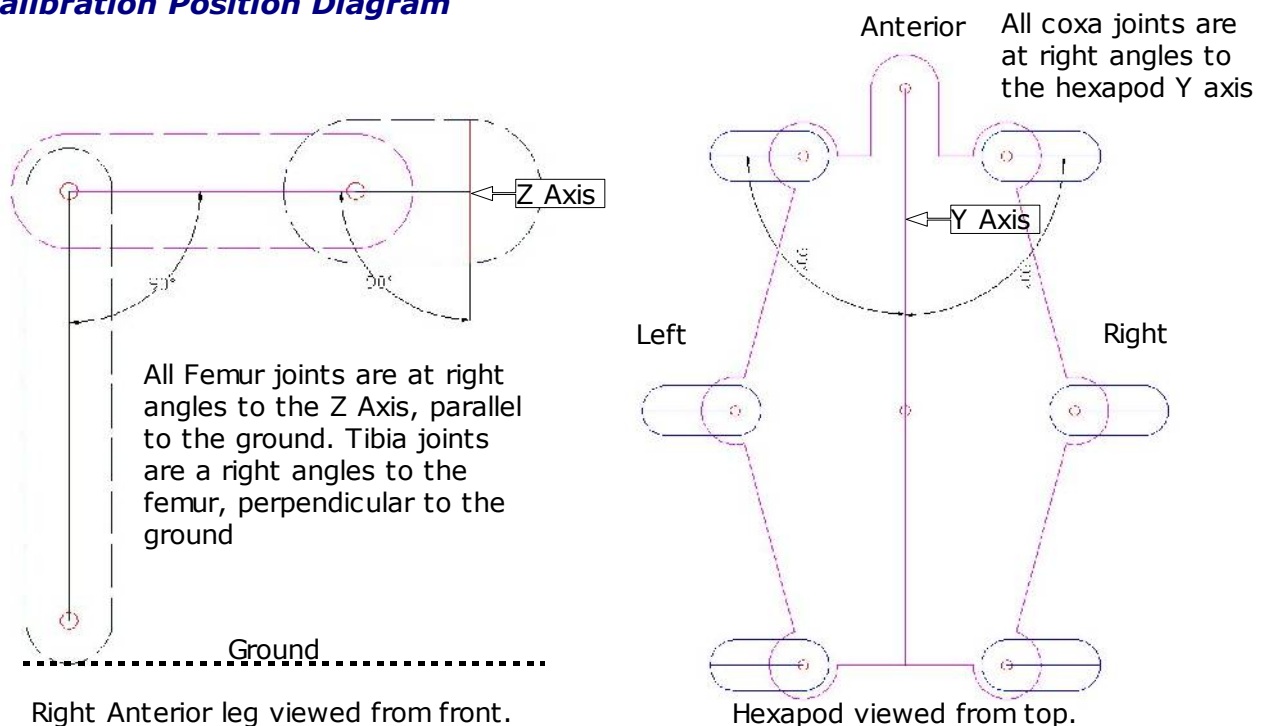

When entering calibration mode global servo refresh is switched off, and is only switched on when the '+' key is pressed. To switch off global servo refresh press the '-' key. You will see a picture of the hexapod at the right side of the screen, with the current leg highlighted in red, to change selected leg use the number keys '1' to '6'. when selecting a leg, all individual servo enable bits are switched off. To enable a servo and start calibration press one of the servo jog keys Coxa: 'A', 'Z', Femur: 'S', 'X', Tibia: 'D', 'C'. The relevant servo will spring into life, and you can adjust its position using the appropriate keys. The calibration position is shown in Picture 5. Once you have a leg calibrated save the data using the 'F' key and move to the next until all 6 legs are done. You can also check the leg movement by pressing the '0' key. This will move the selected leg to the centre angles defined by ACA, MCA, PCA, CFA & CTA. To return to the calibration position press key '9'

Once you have finished calibrating all legs, press 'Q' to quit, you will be prompted to save the calibration data.

Note: It's a good idea to spend time getting your calibration and servo ranges correct, the better the calibration, the smoother your hexapod will move. You can check how good your calibration is working by using the 'Wake' command from the main menu to check the hexapods neutral standing position.

p.Brain-HexEngine (V1.2) Configuration Guide

Cal Info

This command will list the current servo calibration offsets

Leg Info

This command will list the leg tarsus (foot) position in X,Y & Z coordinates, along with the leg joint angles.

Gait Info

This screen displays leg phase, tarsus position (X,Y,Z), leg angles, body rotation and translation, and drive variables. The screen is updated twice a second. Very useful for debugging. To exit this screen press any key. *Note: This screen can be very useful the first time you configure your hexapod. If you are unsure if you have configured the geometry correctly, have a look at the tarsus positions and leg angles within this screen to see if they are what you would expect. You can also disconnect the servo power source and run the hexapod through some moves without the servos moving to check the leg angles first.*

Wake

This will wake the hexapod up from standby mode, e.g. Stand the hexapod up into its neutral standing position. This is for testing purposes.

Sleep

This will put the hexapod into standby mode.

Stop

This will stop the hexapod if it happens to be moving.

Home

If the hexapod is standing, and the legs are not in their neutral position, this will move the legs back to their neutral position, e.g. Relax the hexapod.

Control

When both the locomotion and configuration port are configured to use the same UART, (e.g. Mode 2 & 3 of Port Configuration Table) upon boot the *HexEngine* will default to configuration mode. In order to enter locomotion mode, use the 'CONTROL' command. To return to configuration mode once in locomotion mode, type '@@@' three times with no enter key followed by a one second pause.

Servo Test

This enables direct driving of each servo using the cursor keys left & right to select a servo, and the cursor key up & down to change the servo position. The servo position is listed in micro seconds. There are three pre-defined servo positions using the number keys '1', '2' & '3' which are equal to 1000uS, 1500uS, 2000uS respectively. Pressing one of these keys will drive the servo from its current position to the desired position over a one second interval. Pressing any key during the automated move will stop the servo in the current position. Use the 'Q' key to quit servo test.

p.Brain-HexEngine (V1.2) Configuration Guide

Sim Control

The Sim Control screen offers a very simple locomotion interface to the hexapod for testing and control using single key commands, which allows the hexapod to be controlled using a simple terminal interface. The ENTER key is not required after a command key, for example, to walk forward press and hold the 'w' key, upon releasing the key the hexapod will automatically stop. Upon entering 'Sim Control' the following keys control the hexapod:

Key	Description
+	Power up hexapod
-	Power down hexapod
SPACE	Stop hexapod
!	Emergency stop hexapod (Shuts off servos instantly)
w	Walk forward
s	Walk backwards
a	Turn Left
d	Turn Right
q	Crab Left
e	Crab Right
1	Wave gait 1 (slowest)
2	Wave gait 2
3	Wave gait 3 (In my opinion, the best!)
4	Tripod gait (fastest)
5	On Road gait (fast, fluid)
6	Off Road gait (slower, better ground clearance)
7	Decrease leg transfer speed by 0.1 seconds
8	Increase leg transfer speed by 0.1 seconds
9	Reset leg transfer speed to power on default (DLT)
r	Reset legs to neutral position
b	Switch on full 3D balance mode
c	Switch off full 3D balance mode
ESC	Return to main menu

Port Test

This screen displays the digital and analogue I/O status. The port is configured using the DIO and ADC configuration commands.

PS2 Test

This screen displays the PS2 gamepad status and variables, such as buttons and the two analogue joystick values. See [PS2 Gamepad Control](#) for further information.

p.Brain-HexEngine (V1.2) Configuration Guide

Configuration Menu

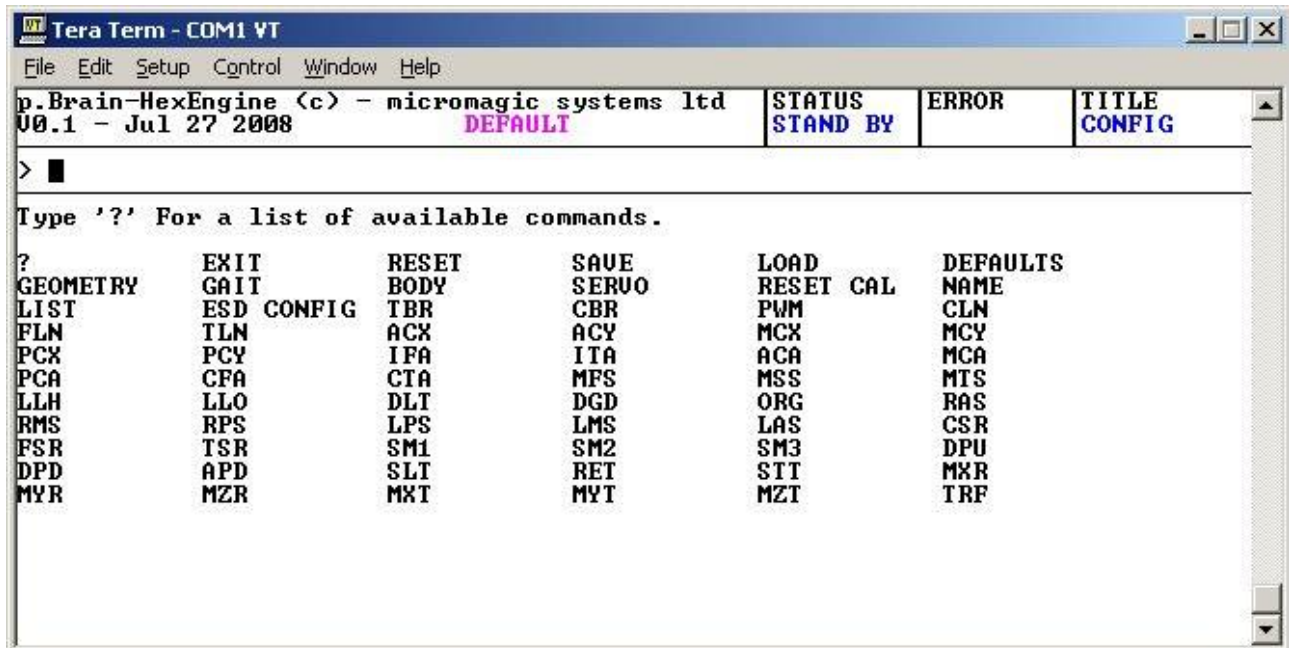

Within this menu all of the geometry, gait and power up settings can be configured. A full list of commands can be viewed by typing '?' followed by the enter key. Most commands are three letters long and are followed by the ENTER key. Commands longer than three letters are used to view parameters and/or change menu's. For example type 'EXIT' to return to the MAIN menu. *Note: When entering the configuration menu, the hexapod will automatically power down. The Pod cannot be run while in configuration mode.*

To query a configuration setting, type the three character command followed by a carriage return (denoted as <cr> in examples). The command will be repeated followed by the current setting. Example to query tibia length:

```
>TLN<cr>

TLN=100.00
```

To change a configuration setting, type the three character command followed by '=' followed by the desired value. If the value is in the valid range for the command, the command and value are echoed back, if the value is outside the valid range for the command, the value is clamped to the nearest limit. Example to set tibia length:

```
> TLN=120.0<cr>

TLN=120.0
```

Example of range clamping:

```
> TLN=0<cr>

TLN=25
```

p.Brain-HexEngine (V1.2) Configuration Guide

Configuration Menu Commands Table

KEY:

COMMANDS

P.BRAIN CONFIGURATION

GEOMETRY CONFIGURATION

GAIT CONFIGURATION

SERVO CONFIGURATION

BEHAVIORAL CONFIGURATION

BODY MOTION CONFIGURATION

Table 1

Command	Description	Units	Min	Max
?	List all available commands within this screen			
EXIT	Exit configuration menu back to main menu			
RESET	Soft reset the <i>p.Brain-ds24</i>			
SAVE	Save all configuration data			
LOAD	Load all configuration data			
DEFAULTS	Reset all configuration data to default values			
GEOMETRY	Displays a List of leg geometry			
GAIT	Displays a list of gait configuration			
BODY	Displays a list of body geometry			
SERVO	Display all servo configuration settings			
RESET CAL	Resets all leg offset calibration data to 0.0			
LIST	LIST all configuration details			
ESD CONFIG	Configure ESD200 blue tooth module			
MSRH01	Reset all configuration data to MSR-H01 kit values			
PHOENIX	Reset all configuration data to PHOENIX kit values			
NAME	Pod file name	string	0	16
TBR	Terminal port BAUD Rate	Integer	0	7
CBR	Control port BAUD Rate	Integer	0	7
PWM	Servo Pulse Width Modulation Range Limit		0	2
CLN	Coxa length	mm	0	300
FLN	Femur length	mm	25	300
TLN	Tibia Length	mm	25	300
ACX	Right Anterior Coxa X	mm	0	250
ACY	Right Anterior Coxa Y	mm	0	250
MCX	Right Middle Coxa X	mm	0	250
MCY	Right Middle Coxa Y (Must be = 0.0)	mm	0	0
PCX	Right Posterior Coxa X	mm	0	250

p.Brain-HexEngine (V1.2) Configuration Guide

Command	Description	Units	Min	Max
PCY	Right Posterior Coxa Y	mm	-250	0
IFA	Initial Femur angle	Degrees	0	90
ITA	Initial Tibia angle	Degrees	-180.0	-90.0
ACA	Anterior Coxa Centre angle	Degrees	-45.0	+45.0
MCA	Middle Coxa Centre angle	Degrees	-45.0	+45.0
PCA	Posterior Coxa Centre angle	Degrees	-45.0	+45.0
CFA	Centre Femur Angle	Degrees	-45.0	+45.0
CTA	Centre Tibia Angle	Degrees	-45.0	+135.0
RAS	Right anterior servo reverse bits	Bits	000	111
RMS	Right middle servo reverses bits	Bits	000	111
RPS	Right posterior servo reverse bits	Bits	000	111
LPS	Left posterior servo reverse bits	Bits	000	111
LMS	Left middle servo reverse bits	Bits	000	111
LAS	Left anterior servo reverse bits	Bits	000	111
CSR	Coxa servo range	Degrees	0.0	180.0
FSR	Femur servo range	Degrees	0.0	180.0
TSR	Tibia servo range	Degrees	0.0	180.0
SM1	Servo Remap SMB Hexapod Standard			
SM2	Servo Remap Inverted SMB Hexapod Standard			
SM3	Servo Remap SMB Standard servo numbering			
MFS	Maximum forward leg stroke (Walk)	mm	5	250
MSS	Maximum sideways leg stroke (Crab)	mm	5	250
MTA	Maximum turn angle (Turn)	Degrees	2	30
LZR	Landing Zone Radius	mm	0	150
LLH	Leg lift height (normal mode)	mm	10	250
LLO	Leg lift height (Off road mode)	mm	10	250
DLT	Default leg transition speed	seconds	0.3	10.0
DGD	Default gait delay	Integer	0	3
ORG	Off road gait enable	bit	0	1
B3D	Full 3D balance gesture	bit	0	1
B3T	3D balance rotation gain	real	0.0	2.0
B3R	3D balance translation gain	real	0.0	2.0
DPU	Default power up height	mm	10	250
DPD	Default power down height	mm	0	250

p.Brain-HexEngine (V1.2) Configuration Guide

Command	Description	Units	Min	Max
APD	Auto power down enable	bit	0	1
SLT	Sleep Time Out	Seconds	1	255
RET	Relax Time Out	Seconds	1	255
STT	Stop Time Out	Seconds	0.5	10.0
RTR	Auto Reset Translate & Rotate	bit	0	1
SRC	Servo Range Check	bit	0	1
ASF	Auxiliary Servo Filter	Integer	0	25
ADC	External Port Analogue / Digital Configure	string	8	8
DIO	External Port Digital Direction Configure I/O	string	8	8
PIP	PIP Packet Mode	bit	0	1
TXD	Command Port Transmission Delay	Integer	0	10
PS2	PS2 Gamepad Control Mode	bit	0	1
MXR	Maximum X Rotation	degrees	0	20
MYR	Maximum Y Rotation	degrees	0	20
MZR	Maximum Z Rotation	degrees	0	20
MXT	Maximum X Translation	mm	0	100
MYT	Maximum Y Translation	mm	0	100
MZT	Maximum Z Translation	mm	0	100
TRF	Translate & Rotate Filter	real	0.0	50.0
PTR	Post-Translate Body	bit	0	1
PAM	Head PAN servo mid position	Integer	500	2500
PA+	Head PAN servo max position	Integer	500	2500
PA-	Head PAN servo min position	Integer	500	2500
TIM	Head TILT servo mid position	Integer	500	2500
TI+	Head TILT servo max position	Integer	500	2500
TI-	Head TILT servo min position	Integer	500	2500
TWM	Head TWIST servo mid position	Integer	500	2500
TW+	Head TWIST servo max position	Integer	500	2500
TW-	Head TWIST servo min position	Integer	500	2500
GRM	Head GRIPPER servo mid position	Integer	500	2500
GR+	Head GRIPPER servo max position	Integer	500	2500
GR-	Head GRIPPER servo min position	Integer	500	2500
LPT	Load PAN/TILT/TWIST mid position upon wake	bit	0	1
HSI	Head Servos Invert Bits	bits	0	111
AHL	Auto Head Leveling	bit	0	1
PTR	Post Translate Body	bit	0	1

p.Brain-HexEngine (V1.2) Configuration Guide

Configuration Menu Commands

P.BRAIN CONFIGURATION

NAME

Set or read the name string of the p.Brain. Example:

```
NAME=MSR-H01<cr>
```

TBR

Set the baud rate for the RS232 terminal port UART2 on the dsPIC, see [Table 2](#) for available baud rates. *Note: The first time the HexEngine is run, the terminal baud rate should be 115200kbps. All port communications are 8 Bit, No parity, 1 Stop bit (**8N1**)*

Table 2

Configuration Value	Baud Rate	Configuration Value	Baud Rate
0	1200	4	19200
1	2400	5	38400
2	4800	6	57600
3	9600	7	115200

CBR

Set the baud rate for the TTL terminal port UART1 on the dsPIC, see [Table 2](#) for available baud rates. The baud rate error is listed next to the baud rate, with higher baud rate errors, problems may occur if the host system also has a baud rate error of the opposite magnitude. For the first time the *HexEngine* is run, the control baud rate should be 9600kbps. *Note: All port communications are 8 Bit, No parity, 1 Stop bit (**8N1**). If you change the CBR setting and you are using an ESD200 blue tooth module, you will need to run the ESD CONFIG command to configure the ESD200 to the new baud rate.*

PWM

Set the global maximum and minimum PWM servo output range. There are three settings, standard, extended and full. Most servo will operate quite happily with standard and extended ranges, however, not all servos will tolerate the full range. Most analogue servos will accept full range signals, but may have mechanical stops which prevent full range use, many digital servos have full range mechanical capabilities, but cut out if the signal goes beyond the extended range limits. It is rare that a hexapod will need the full range limits, and therefore I suggest using either standard or extended limits.

Setting	PWM Minimum	PWM Maximum	Approx. Rotation (degrees)
0	1000	2000	+/- 50
1	800	2200	+/- 70
2	600	2400	+/- 90
3	500	2500	+/- 100

p.Brain-HexEngine (V1.2) Configuration Guide

GEOMETRY CONFIGURATION

CLN

Coxa Length. The distance from the centre of the coxa servo spline, to the centre of the femur servo spline. (See [Diagram 2](#))

FLN

Femur Length. The length from the centre of the femur servo spline, to the centre of the tibia servo spline. (See [Diagram 2](#))

TLN

Tibia Length. The length from the centre of the tibia servo spline to the end of the tibia/foot. (See [Diagram 2](#))

ACX

Anterior Coxa X. Distance from anterior coxa servo centre to centre of body in X direction. This is the same for both left and right anterior coxa joints. *Note: The right side of the hexapod is positive X direction.* (See [Diagram 1](#))

ACY

Anterior Coxa Y. Distance from anterior coxa servo centre to centre of body in Y direction. This is the same for both left and right anterior coxa joints. *Note: The anterior of the hexapod is positive Y direction.* (See [Diagram 1](#))

MCX

Middle Coxa X. Distance from middle coxa servo centre to centre of body in X direction. This is the same for both left and right middle coxa joints. (See [Diagram 1](#))

MCY

Middle Coxa Y. Distance from middle coxa servo centre to centre of body in Y direction. This is the same for both left and right middle coxa joints. *Note: The middle coxa joint must be in the middle of the body, therefore this value must be 0.0.* (See [Diagram 1](#))

PCX

Posterior coxa X. Distance from posterior coxa servo centre to centre of body in X direction. This is the same for both left and right posterior coxa joints. (See [Diagram 1](#))

PCY

Posterior Coxa Y. Distance from posterior coxa servo centre to centre of body in Y direction. This is the same for both left and right posterior coxa joints. *Note: The anterior of the hexapod is positive Y direction.* (See [Diagram 1](#))

IFA

Initial Femur Angle. This is the femur angle when the hexapod is in its neutral standing position. *Note: This value is only used during the hexapod power up in order to set the initial leg angles and placement. The DPU setting is also used to calculate the initial standing position, therefore the final standing femur angle may differ from the value set for IFA.*

ITA

Initial Tibia Angle. This is the tibia angle when the hexapod is in its neutral standing position. *Note: This value is only used during the hexapod power up in order to set the initial leg angles and placement. The DPU is also used to calculate the initial standing position, therefore the final standing femur angle may differ from the value set for IFA.*

p.Brain-HexEngine (V1.2) Configuration Guide

ACA

Anterior Coxa Angle. This is the anterior coxa angle when the hexapod is at its neutral standing position, also the centre position for coxa swing. *Note: This angle is set for the right coxa, and is automatically mirrored for the left coxa.* (See [Diagram 1](#))

MCA

Middle Coxa Angle. This is the middle coxa angle when the hexapod is at its neutral standing position, also the centre position for coxa swing. (See [Diagram 1](#))

PCA

Posterior Coxa Angle. This is the posterior coxa leg angle when the hexapod is at its neutral standing position, also the centre position for the coxa swing. (See [Diagram 1](#))

Diagram 1 - Body Geometry Details

The following diagram viewed from the top of the hexapod indicates the measuring points for the body geometry settings. *Note: MCX and MCA are set to zero and are not shown on the diagram.*

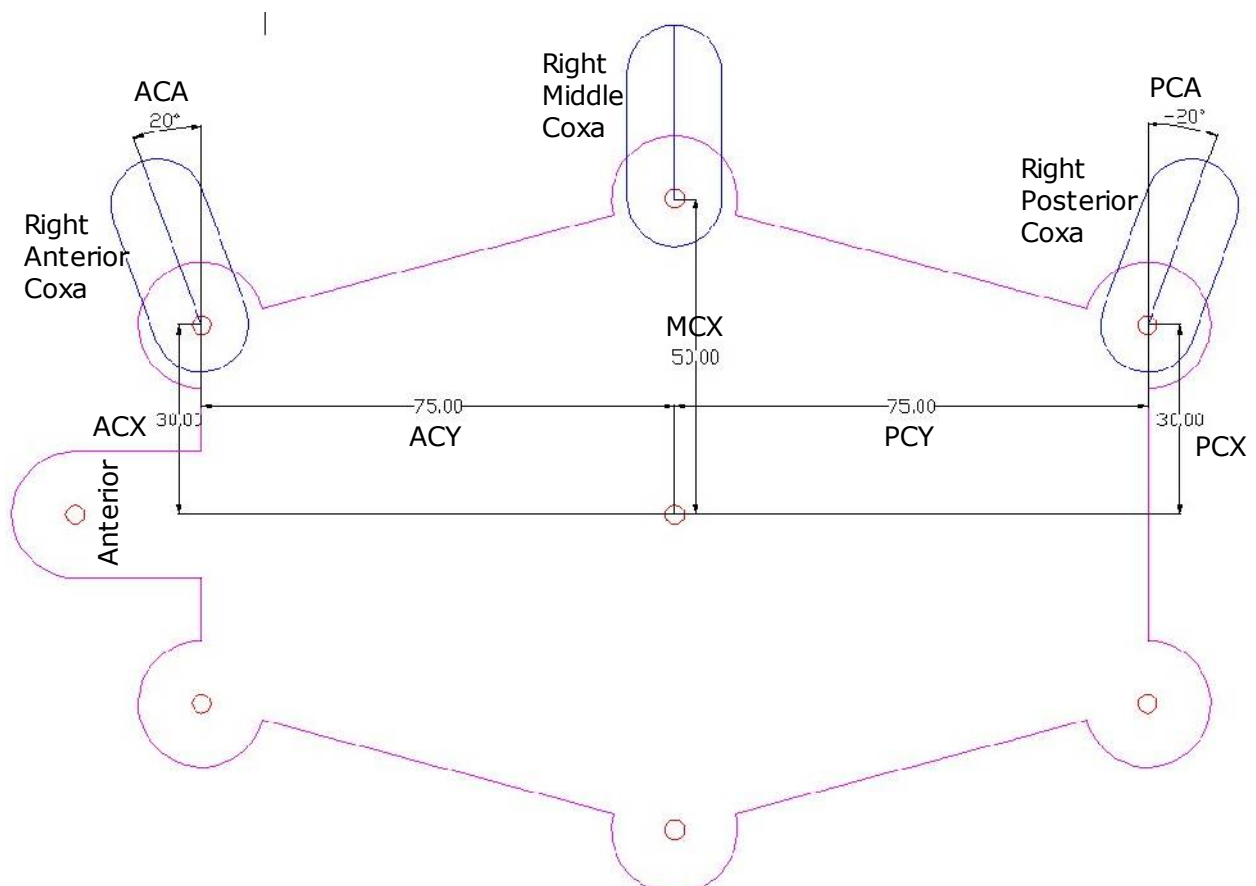

p.Brain-HexEngine (V1.2) Configuration Guide

CFA

Centre Femur Angle. This setting defines the centre position of the femur, for example, most of my hexapods use a femur leg swing range of 0.0 to 90.0 degrees, so the CFA is set to 45.0 degrees. Essentially this is where the servo PWM signal will be at its neutral of 1500uS. (See [Diagram 2](#))

CTA

Centre Tibia Angle. This setting defines the centre position of the tibia, for example, most of my hexapods use a tibia leg swing range of -90 to -180.0 degrees, so the CFA is set to -135.0 degrees. Essentially this is where the servo PWM signal will be at its neutral of 1500uS. (See [Diagram 2](#))

Diagram 2 – Leg Geometry Details

These angles may seem strange at first, this is due to the way the Inverse Kinematic model was created. If you are looking at the right anterior leg from the front, when the femur is pointing straight out from the body parallel to the ground the femur angle is 0.0 degrees. Now if the tibia is also pointing straight out from the body parallel to the ground the tibia angle is 0.0 degrees. Now if we rotate the femur 45.0 degrees clockwise and tibia 135 degrees anticlockwise the foot should now points towards the ground. This is the position most of my hexapods use for the CFA & CTA angles.

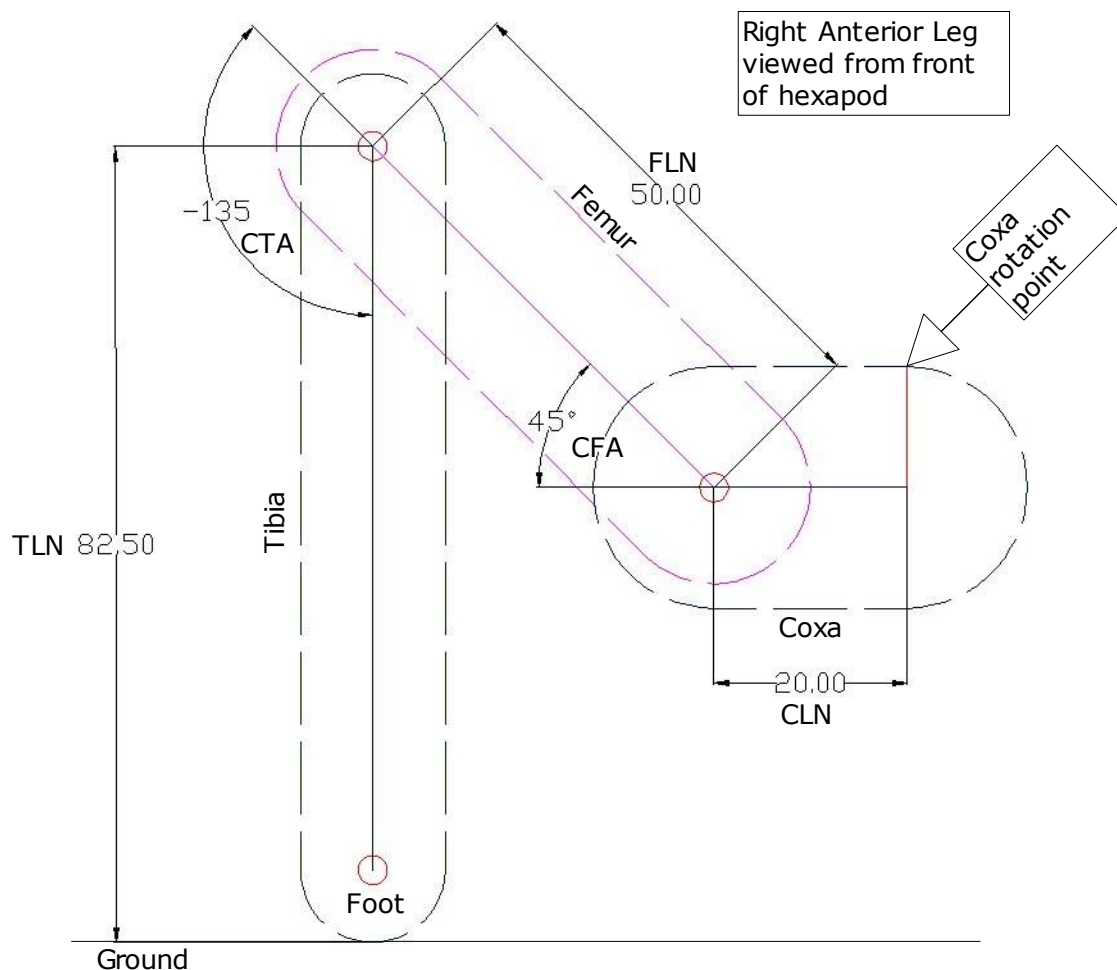

p.Brain-HexEngine (V1.2) Configuration Guide

GAIT CONFIGURATION

MFS

Maximum Forward Stroke: This defines the maximum forward & backwards leg stroke the hexapod can take. This is one of the configuration settings that determines the speed of the hexapod. If in doubt start with a low figure such as 10, then try your hexapod out going forwards at full speed, depending on its size the hexapod should be taking fairly small steps approximately 10mm long. *Note: There are no checks to see if this value is within the physical range of the hexapods legs, therefore setting an unrealistic value may result in servo collisions & or IK maths errors.*

MSS

Maximum Side Stroke: This defines the maximum side stroke / crabbing stroke the hexapod can take. This is one of the configuration settings that determines the speed of the hexapod. If in doubt start with a low figure such as 10, then try your hexapod out going sideways at full speed, depending on its size the hexapod should be taking fairly small steps approximately 10mm long. *Note: There are no checks to see if this value is within the physical range of the hexapods legs, therefore setting an unrealistic value may result in servo collisions & or IK maths errors.*

MTA

Maximum Turn Angle: This defines the maximum turning speed of the hexapod. Start with a value of 10 degrees and test, high values will be clamped by the LZR setting, and may produce strange walking patterns. *Note: There are no checks to see if this value is within the physical range of the hexapods legs, therefore setting an unrealistic value may result in servo collisions & or IK maths errors.*

LZR

Landing Zone Radius: This value can be seen as a circle with its centre at the neutral/resting point of the foot of each leg. If this value is non zero, when a new leg step position is calculated, the foot must fall within this working radius, if it does not, the foot will be limited to the extremity of the LZR radius.

LLH

Leg Lift Height: This value determines the height the leg is lifted when the hexapod is taking a step. *Note: There are no checks to see if this value is within the physical range of the hexapods legs, therefore setting an unrealistic value may result in servo collisions & or IK maths errors.*

LLO

Leg Lift Off-Road: This value determines the height the leg is lifted when the hexapod is taking a step using the off-road gait method. *Note: There are no checks to see if this value is within the physical range of the hexapods legs, therefore setting an unrealistic value may result in servo collisions & or IK maths errors.*

DLT

Default Leg Transition Speed: This value sets the initial transition speed of the leg to take a step from A to B. This value is in seconds, and therefore a lower value gives a faster leg transition speed. The leg transition speed can be changed in real time using the hexapod control API. *Note: The maximum speed for the leg to move is determined by the servos being used, fast leg speed may damage some servos!*

p.Brain-HexEngine (V1.2) Configuration Guide

DGD

Default Gait Delay: This value sets the initial gait delay. The gait delay determines the way the legs are sequenced as the hexapod moves (See [Table 3](#)). The gait delay can also be changed in real time using the hexapod control interface.

Table 3

Gait Delay	Gait Style	Legs in contact with ground
3	Wave 1	5
2	Wave 2	4
1	Wave 3	4
0	Tripod	3

ORG

Off Road Gait: This switch enables the off road walking gait. In this mode to take a step the legs follow this sequence: protract -> move -> retract. This gives a much more robot like move but does offer better obstacle clearance. When not using the off-road gait, to take a step the legs protract and retract during the move, this gives a much faster more fluid look.

B3D

Full 3D balance: This option switches on the full 3D balance gesture engine. With this enabled, the hexapod body moves according to the position of the legs, which gives a more natural body movement. With this option disabled, the hexapod body is kept stable as the legs move.

B3T

3D balance translation gain: This value controls the level of body translation in 3D balance mode. Setting to 0.0 will switch off translation, setting to 2.0 will double the standard amount.

B3R

3D balance rotation gain: This value controls the level of body rotation in 3D balance mode. Setting to 0.0 will switch off rotation, setting to 2.0 will double the standard amount.

p.Brain-HexEngine (V1.2) Configuration Guide

SERVO CONFIGURATION

RAS

Right Anterior Servo: This value sets the individual servo reverse bits for the right anterior leg. The value is entered in the form: Coxa, Femur, Tibia (CFT), e.g. a value of 000 means none of the servos are reversed, a value of 010 means only the femur servo is reversed. (See [Diagram 3](#))

RMS

Right Middle Servo: This value sets the individual servo reverse bits for the right middle leg. The value is entered in the form: Coxa, Femur, Tibia (CFT), e.g. a value of 000 means none of the servos are reversed, a value of 010 means only the femur servo is reversed. (See [Diagram 3](#))

RPS

Right Posterior Servo: This value sets the individual servo reverse bits for the right posterior leg. The value is entered in the form: Coxa, Femur, Tibia (CFT), e.g. a value of 000 means none of the servos are reversed, a value of 010 means only the femur servo is reversed. (See [Diagram 3](#))

LPS

Left Posterior Servo: This value sets the individual servo reverse bits for the left posterior leg. The value is entered in the form: Coxa, Femur, Tibia (CFT), e.g. a value of 000 means none of the servos are reversed, a value of 010 means only the femur servo is reversed. (See [Diagram 3](#))

LMS

Left Middle Servo: This value sets the individual servo reverse bits for the left middle leg. The value is entered in the form: Coxa, Femur, Tibia (CFT), e.g. a value of 000 means none of the servos are reversed, a value of 010 means only the femur servo is reversed. (See [Diagram 3](#))

LAS

Left Anterior Servo: This value sets the individual servo reverse bits for the left anterior leg. The value is entered in the form: Coxa, Femur, Tibia (CFT), e.g. a value of 000 means none of the servos are reversed, a value of 010 means only the femur servo is reversed. (See [Diagram 3](#))

CSR

Coxa Servo Range: This setting specified in degrees, determines the servo travel range for the coxa servos. For example, a standard PWM servo signal is from 1 to 2 milliseconds in length and would drive a standard servo 90 degrees. However, most servos differ slightly between makes and models and so this value can be trimmed to suit. If this value is not set correctly, the *HexEngine* will not produce accurate movements. *Note: See [Table 4](#) for a list of known servos and their appropriate range values.*

FSR

Femur Servo Range: This setting specified in degrees, determines the servo travel range for the femur servos. See CSR for a more detailed explanation.

TSR

Tibia Servo Range: This setting specified in degrees, determines the servo travel range for the tibia servos. See CSR for a more detailed explanation.

p.Brain-HexEngine (V1.2) Configuration Guide

Table 4

Servo movement in degrees for PWM of 1 to 2 milliseconds.

Make	Model	Servo Range
Hitec	HS-475HB	99.5
Hitec	HS-645MG	99.5
Hitec	HS-225BB	92.5
Kondo	KRS788HV	104.0

Diagram 3 – Servo Reverse Settings

The picture below show the right front anterior leg with the servos mounted in a standard configuration. Assuming these are Hitec servos the servo reverse setting for this leg (RAS) would be = 000. This means all the servo joints are normal travel direction. This would be the same for any type of servo which rotates in the same direction as a Hitec servo. If you were to use a servo which had reverse direction rotation, RAS would need to be 111, the exact opposite. *Note: Many of my hexapod have the posterior legs mounted in reverse to the anterior and middle legs, this is for aesthetic and sometimes mechanical reasons. In this scenario the setting for RPS & LPS would be : 111.*

The table below lists servo reverse settings for standard and reverse direction servo types. Hitec servos have been used for the purpose of defining a standard direction: Increasing the Pulse Width turns the servo horn in a clockwise direction.

Servo Direction	Standard configuration LEG	Reverse Bit Settings
Standard	Right Anterior	RAS = 000
Standard	Right Middle	RMS = 000
Standard	Right Posterior	RPS = 000
Standard	Left Posterior	LPS = 000
Standard	Left Middle	LMS = 000
Standard	Left Anterior	LAS = 000
Reverse	Right Anterior	RAS = 111
Reverse	Right Middle	RMS = 111
Reverse	Right Posterior	RPS = 111
Reverse	Left Posterior	LPS = 111
Reverse	Left Middle	LMS = 111
Reverse	Left Anterior	LAS = 111

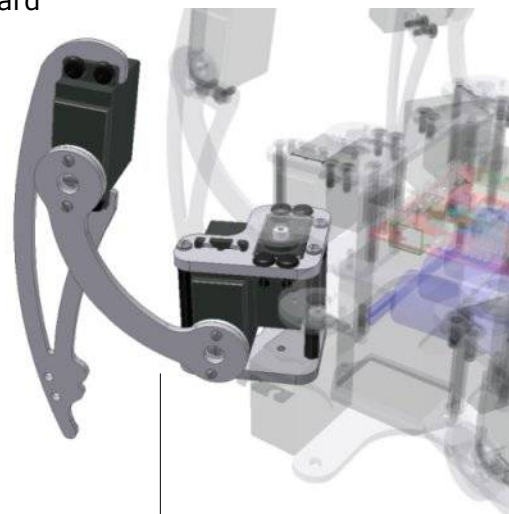

Standard servo mounting & orientation for right anterior leg. Left leg configured as mirror of right.

p.Brain-HexEngine (V1.2) Configuration Guide

Note: SM1 & SM2 Settings differ for the p.Brain-SMB and p.Brain- μ 24 modules, please see the relevant sections below.

SM1 (For p.Brain-SMB)

Servo Remap Hexapod Standard: This setting will set the servo remap for the *p.Brain-SMB* to the standard Hexapod configuration, with the *SMB* mounted above or below the top chassis plate with the servo pins facing up. See diagram & table below for servo output configuration.

RIGHT LEG LEFT LEG

SMB Servo Number	Leg / Joint	SMB Servo Number	Leg / Joint
1	Auxiliary Servo 1	13	Left Posterior Coxa
2	Auxiliary Servo 2	14	Left Posterior Femur
3	Auxiliary Servo 3	15	Left Posterior Tibia
4	Right Anterior Coxa	16	Left Middle Coxa
5	Right Anterior Femur	17	Left Middle Femur
6	Right Anterior Tibia	18	Left Middle Tibia
7	Right Middle Coxa	19	Left Anterior Coxa
8	Right Middle Femur	20	Left Anterior Femur
9	Right Middle Tibia	21	Left Anterior Tibia
10	Right Posterior Coxa	22	Auxiliary Servo 4
11	Right Posterior Femur	23	Auxiliary Servo 5
12	Right Posterior Tibia	24	Auxiliary Servo 6



p.Brain-HexEngine (V1.2) Configuration Guide

SM2 (For p.Brain-SMB)

Servo Remap Hexapod Reversed: This setting will set the servo remap for the *p.Brain-SMB* to the inverted Hexapod configuration, with the *SMB* mounted above or below the top chassis plate with servo pins pointing down. See table below for servo output configuration.

RIGHT LEG LEFT LEG

SMB Servo Number	Leg / Joint	SMB Servo Number	Leg / Joint
1	Auxiliary Servo 6	13	Right Posterior Tibia
2	Auxiliary Servo 5	14	Right Posterior Femur
3	Auxiliary Servo 4	15	Right Posterior Coxa
4	Left Anterior Tibia	16	Right Middle Tibia
5	Left Anterior Femur	17	Right Middle Femur
6	Left Anterior Coxa	18	Right Middle Coxa
7	Left Middle Tibia	19	Right Anterior Tibia
8	Left Middle Femur	20	Right Anterior Femur
9	Left Middle Coxa	21	Right Anterior Coxa
10	Left Posterior Tibia	22	Auxiliary Servo 3
11	Left Posterior Femur	23	Auxiliary Servo 2
12	Left Posterior Coxa	24	Auxiliary Servo 1

SM3 (For p.Brain-SMB & p.Brain-µ24)

Servo Remap Standard Numbering: This setting will set the servo remap for the *p.Brain-SMB* to the standard numbering of the *SMB*, see table below.

RIGHT LEG LEFT LEG

SMB Servo Number	Leg / Joint	SMB Servo Number	Leg / Joint
1	Right Anterior Coxa	13	Left Middle Coxa
2	Right Anterior Femur	14	Left Middle Femur
3	Right Anterior Tibia	15	Left Middle Tibia
4	Right Middle Coxa	16	Left Anterior Coxa
5	Right Middle Femur	17	Left Anterior Femur
6	Right Middle Tibia	18	Left Anterior Tibia
7	Right Posterior Coxa	19	Auxiliary Servo 1
8	Right Posterior Femur	20	Auxiliary Servo 2
9	Right Posterior Tibia	21	Auxiliary Servo 3
10	Left Posterior Coxa	22	Auxiliary Servo 4
11	Left Posterior Femur	23	Auxiliary Servo 5
12	Left Posterior Tibia	24	Auxiliary Servo 6

p.Brain-HexEngine (V1.2) Configuration Guide

SM1 (For p.Brain- μ 24)

Servo Remap Hexapod Standard: This setting will set the servo remap for the *p.Brain- μ 24* to the standard Hexapod configuration, with the μ 24 mounted above or below the top chassis plate with the servo pins facing up. See diagram & table below for servo output configuration.

RIGHT LEG LEFT LEG

μ 24 Servo Number	Leg / Joint	μ 24 Servo Number	Leg / Joint
1	Auxiliary Servo 1	13	Left Posterior Coxa
2	Right Anterior Coxa	14	Left Posterior Femur
3	Right Anterior Femur	15	Left Posterior Tibia
4	Right Anterior Tibia	16	Auxiliary Servo 4
5	Auxiliary Servo 2	17	Left Middle Coxa
6	Right Middle Coxa	18	Left Middle Femur
7	Right Middle Femur	19	Left Middle Tibia
8	Right Middle Tibia	20	Auxiliary Servo 5
9	Auxiliary Servo 3	21	Left Anterior Coxa
10	Right Posterior Coxa	22	Left Anterior Femur
11	Right Posterior Femur	23	Left Anterior Tibia
12	Right Posterior Tibia	24	Auxiliary Servo 6

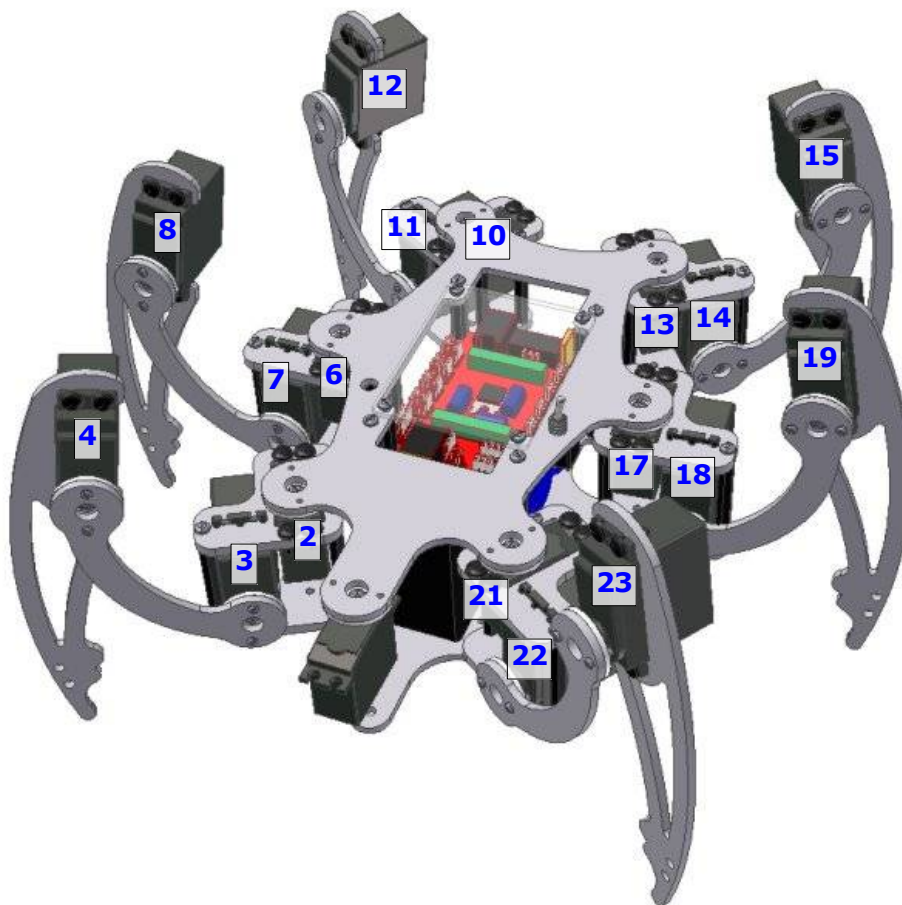

p.Brain-HexEngine (V1.2) Configuration Guide

SM2 (For p.Brain- μ 24)

Servo Remap Hexapod Reversed: This setting will set the servo remap for the *p.Brain- μ 24* to the inverted Hexapod configuration, with the μ 24 mounted above or below the top chassis plate with servo pins pointing down. See table below for servo output configuration.

RIGHT LEG LEFT LEG

μ 24 Servo Number	Leg / Joint	μ 24 Servo Number	Leg / Joint
1	Auxiliary Servo 6	13	Right Posterior Tibia
2	Left Anterior Tibia	14	Right Posterior Femur
3	Left Anterior Femur	15	Right Posterior Coxa
4	Left Anterior Coxa	16	Auxiliary Servo 3
5	Auxiliary Servo 5	17	Right Middle Tibia
6	Left Middle Tibia	18	Right Middle Femur
7	Left Middle Femur	19	Right Middle Coxa
8	Left Middle Coxa	20	Auxiliary Servo 2
9	Auxiliary Servo 4	21	Right Anterior Tibia
10	Left Posterior Tibia	22	Right Anterior Femur
11	Left Posterior Femur	23	Right Anterior Coxa
12	Left Posterior Coxa	24	Auxiliary Servo 1

Pan/Tilt Head Servo Map

<i>p.Brain-SMB Servo Number</i>	<i>p.Brain-μ24 Servo Number</i>	<i>Pan/Tilt function</i>
Auxiliary 1	Auxiliary 1	Head Pan
Auxiliary 2	Auxiliary 6	Head Tilt
Auxiliary 3	Auxiliary 2	Head Twist
Auxiliary 4	Auxiliary 5	Head Gripper

p.Brain-HexEngine (V1.2) Configuration Guide

BEHAVIORAL CONFIGURATION

DPU

Default Power Up Height: This is the neutral standing height for the hexapod. This value is used in conjunction with GFA and GTA to determine the neutral position of the hexapod. This value should be a positive, greater than DPD and greater than the distance from the centre of the coxa spline to the base of the hexapod.

DPD

Default Power Down Height: This is the resting position for the legs when the hexapod powers down. This value should be positive and greater than or equal to the distance from the centre of the coxa spline to the base of the hexapod.

APD

Auto Power Down: When enabled, the hexapod will automatically power down to the rest position if no control commands have been received within 30 seconds.

SLT

Sleep Time: If auto power down 'APD' is enabled, this variable determines how many seconds pass since the last locomotion command before the hexapod sleeps.

RET

Relax Time: This variable determines how many seconds pass since the last locomotion command before the hexapod returns all legs to the neutral standing position.

SST

Stop Time: This variable determines how many seconds pass since the last locomotion command before the hexapod stops moving. e.g. If a walk forward command is sent, the hexapod will automatically stop after 'SST' seconds if no further commands are sent. Useful for loss of communications!

RTR

Reset Translate & Rotate: This switch enables the automatic reset of body translation and rotation to 0, when a PIP movement command is sent. For example, if the hexapod is stood still, and the body rotated in X by 10 degrees, as soon as the hexapod receives a PIP move command, the body rotation and translation are reset to 0 which will level out the body before walking.

SRC

Servo Range Check: This option enables or disables the servo range check, if SRC is enabled (=1) and a servo reaches its minimum or maximum PWM value, the hexapod engine issues an error message and all signals to the servos are stopped. A wake command needs to be sent to restart the HexEngine.

ASF

Auxiliary Servo Filter: This value sets the amount of filtering to apply to auxiliary servo position data sampled via the PIP command 'A'. Setting this value to zero, will switch off any filtering and will result in fast instant moves which can cause damage to servos if not used wisely!

ADC

External Port Function Configure: This string value configures the p.Brain-ds24 external port pins (CN19 on p.Brain-SMB) to either Digital I/O or Analogue capture. The string must be 8 characters long and can contain only 'A' or 'D' characters. For example to configure the top nibble as analogue and the bottom nibble as digital, enter the following: ADC=AAAADDDD

p.Brain-HexEngine (V1.2) Configuration Guide

DIO

External Port I/O Configure: This string value configures the p.Brain-ds24 external port pin direction (CN19 on p.Brain-SMB). The pin must be configured as digital using the "ADC" command in order to operate as digital I/O. The string must be 8 characters long and can contain only 'I' or 'O' characters. For example, if ADC=DDDDDDDD, to configure the top nibble as inputs and the bottom nibble as outputs, enter the following: DIO=IIIIIOOOO. *Note, Digital inputs 0 to 5 have weak internal pull-up's, inputs 6 and 7 do not. There are no output current limiting resistors on the digital ports, take care not to short or overload the pins, maximum current source and sink per pin is 4 mA.*

PIP

Packet Interface Protocol Mode: This setting defines the PIP mode, either 0 or 1. Please see the HexEngine PIP Guide for further details on the PIP and PIP modes.

TXD

Transmission Delay: When controlling the HexEngine from micro processors that do not have hardware uarts such as the basic stamp series, it is necessary to add a transmission delay to packets in order to give the connected micro time to switch to data reception after a PIP transmission. This is only necessary in two way communications such as reading from the HexEngine I2C port. The TXD parameter adds a number of 0xff bytes to the header of each PIP packet.

PS2

PS2 Gamepad Control: Setting this value to 1 will enable the internal PS2 gamepad control module. See [PS2 Gamepad Control](#) for further details.

BODY MOTION CONFIGURATION

MXR

Maximum X Rotation: This defines the maximum body X rotation in degrees. When controlling the hexapod using the control interface, binary values of 0 to 255 are scaled between -MXR and +MXR degrees.

MYR

Maximum Y Rotation: This defines the maximum body Y rotation in degrees. When controlling the hexapod using the control interface, binary values of 0 to 255 are scaled between -MYR and +MYR degrees.

MZR

Maximum Z Rotation: This defines the maximum body Z rotation in degrees. When controlling the hexapod using the control interface, binary values of 0 to 255 are scaled between -MZR and +MZR degrees.

MXT

Maximum X Translation: This defines the maximum body X translation in millimetres. When controlling the hexapod using the control interface, binary values of 0 to 255 are scaled between -MXT and +MXT mm.

MYT

Maximum Y Translation: This defines the maximum body Y translation in millimetres. When controlling the hexapod using the control interface, binary values of 0 to 255 are scaled between -MYT and +MYT mm.

p.Brain-HexEngine (V1.2) Configuration Guide

MZT

Maximum Z Translation: This defines the maximum body Z translation in millimetres. When controlling the hexapod using the control interface, binary values of 0 to 255 are scaled between -MZT and +MZT mm.

TRF

Translation & Rotation Filter: This value sets the amount of filtering to apply to body translations & rotations. Setting this value to zero, will switch off any filtering and will result in fast instant moves which can cause damage to servos if not used wisely!

PTR

Post-Translate body: When this is set, the body translation happens after the body rotation, so if the head is pinging towards the ground, and the body is translated forward the body will translate along the new rotated axis. If this bit is clear (0), the body will translate along the original ground axis and is not effected by the body rotation.

Head Configuration.

The following settings control the head pan, tilt, twist and grip servo limits. These servos are internally mapped to auxiliary servos, see page 25 for details. Head limits are used by the PIP command 'H' and the PS2 game pad control interface.

PAM

PAN Servo Middle: This value sets the pan servo middle position in micro seconds. Therefore for the standard servo centre position this would be 1500.

PA+

PAN Servo Maximum: This value sets the pan servo maximum position in micro seconds. Therefore for the standard servo range 45° would be approximately 2000.

PA-

PAN Servo Minimum: This value sets the pan servo minimum position in micro seconds. Therefore for the standard servo range -45° would be approximately 1000.

TIM

TILT Servo Middle: This value sets the tilt servo middle position in micro seconds. Therefore for the standard servo centre position this would be 1500.

TI+

TILT Servo Maximum: This value sets the tilt servo maximum position in micro seconds. Therefore for the standard servo range 45° would be approximately 2000.

TI-

TILT Servo Minimum: This value sets the tilt servo minimum position in micro seconds. Therefore for the standard servo range -45° would be approximately 1000.

TWM

TWIST Servo Middle: This value sets the tilt servo middle position in micro seconds. Therefore for the standard servo centre position this would be 1500.

TW+

TWIST Servo Maximum: This value sets the tilt servo maximum position in micro seconds. Therefore for the standard servo range 45° would be approximately 2000.

p.Brain-HexEngine (V1.2) Configuration Guide

TW-

TWIST Servo Minimum: This value sets the tilt servo minimum position in micro seconds. Therefore for the standard servo range -45° would be approximately 1000.

GRM

GRIPPER Servo Middle: This value sets the tilt servo middle position in micro seconds. Therefore for the standard servo centre position this would be 1500.

GR+

GRIPPER Servo Maximum: This value sets the tilt servo maximum position in micro seconds. Therefore for the standard servo range 45° would be approximately 2000.

GR-

GRIPPER Servo Minimum: This value sets the tilt servo minimum position in micro seconds. Therefore for the standard servo range -45° would be approximately 1000.

LPT

Load Pan/Tilt: When LPT is set to 1, the pan and tilt head mid positions stored in PAM & TIM respectively are re-loaded when the hexapod wakes up, effectively resetting the head position to neutral.

HSI

This is the individual servo reverse bits for the three head servos in the order MSB to LSB, Pan, Tilt, Twist. Setting the associated bit to 1, will invert the servo direction, e.g. HSI=001 Would have the Twist servo inverted.

AHL

Auto Head Level, with this bit set to 1, the auto head levelling feature is enabled, now when the body is rotated, the head will counter rotate in an appropriate direction to keep the head level at its current position. If the head rotates in the same direction as the body, invert the associated servo using the HSI setting.

PTR

Post Translate Body. Usually the body translation maths happens before the body rotation functions, therefore a translation would continue along the new rotated axis. With PTR enabled, the body translation function happens after the body rotation function, this causes the body to translate along the original axis. If in doubt, give it a go and see the difference.

p.Brain-HexEngine (V1.2) Configuration Guide

ESD200 Bluetooth configuration – p.Brain-SMB

This section explains the *HexEngine* "ESD CONFIG" command. This command attempts to configure the ESD200 or ESD100 ready to work with the *HexEngine*. *Note: Have a copy of the p.Brain-SMB to hand to help installation and jumper identification.*

ESD Installation

To install your ESD200, remove power from your *p.Brain-SMB*, connect the ESD200 to the *SMB* as indicated in the picture. Install jumper JP1-2, Have JP1-1 ready but not installed. JP1-1 connects the ESD200 transmitter to UART1 receiver on the *p.Brain-ds24*.

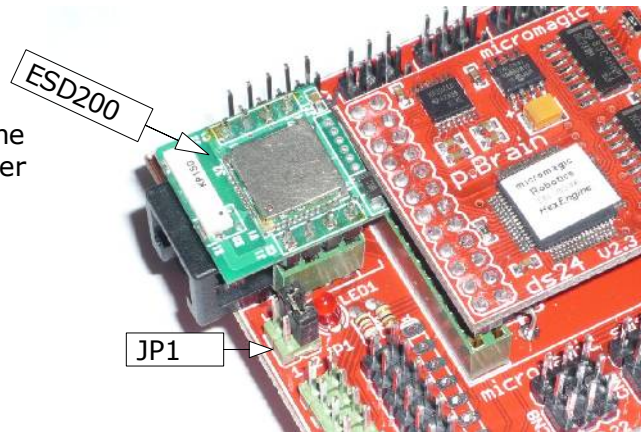

ESD Configuration

Switch on power to your *p.Brain-SMB*, and *HexEngine*. Go to the "CONFIG" screen and type "ESD CONFIG"

The first prompt you will see is to reset the ESD200 to factory defaults, this is achieved by shorting JP1-1 out for a couple of seconds, and then removing the JP1-1 link. Once this has been done continue with the configuration by typing "y".

You should see a series of program operations which configure the device. After each parameter is set, a response of "OK" should appear in red on the right of the screen confirming configuration. All but the last command "ATZ" should receive an "OK" response, if any of the responses are not "OK", try the configuration procedure again. *Note: The baud rate setting for the ESD200 is determined by the HexEngine "CBR" parameter.*

The bluetooth pass key or pin code is: 1138 *This is only true for version 1.2 and higher of the HexEngine, for versions below 1.2, please see the relative documentation.*

Once configuration is complete, your ESD200 should now be in discover mode, this means that you should be able to pair with your ESD200 using Windows bluetooth utility or similar. During the pairing procedure you will be asked for the pass key defined above. When pairing is complete, you should be able to connect you your ESD200 with the COM port assigned by your host operating system.

LED1

The LED next to the ESD200 (LED1) on the *p.Brain-SMB* board is the connection LED. This should illuminate when a connection is made between the device and a host system. *Note I have noticed in some cases the LED does not light even when a connection is established, this seems to be determined by the host software initiating the connection!?*

p.Brain-HexEngine (V1.2) Configuration Guide

ESD Manual Configurations

The ESD200 device can be manually configured using a suitable RS-232 interface and terminal software. For further information on connecting the ESD to a serial port, please see the ESD200 user guide.

Following a factory reset, the "ESD CONFIG" command runs the following terminal commands on the ESD device: *Note: All commands are followed with a carriage return.*

Command	Description	Reply
AT	See if device is connected	OK
AT+BTKEY=1138	Set the PIN code	OK
AT+BTSEC,1,0	Pin Authentication on Encryption off	OK
ATS3=1	Fast Operation on	OK
AT+BTMODE,3	Set Discovery mode on	OK
ATS37=8000	Set link lost time out = 5 seconds	OK
AT+UARTCONFIG,x,N,1,0	Configure Uart, x = BAUD rate e.g. 9600	OK
ATZ	Soft reset	OK

p.Brain-HexEngine (V1.2) Configuration Guide

ESD200 Bluetooth configuration – p.Brain-μ24

ESD Installation

To install your ESD200, remove power from your *p.Brain-μ24*, connect the ESD200 to the *SMB* as indicated in the picture. Install jumper JP1 as indicated in the picture. Install jumper JP1 in the B position.



ESD Configuration

Before you configure the ESD200 device, you may need to change the desired baud rate, this defaults to 115200. If you require a different baud rate, you will need to use the RJ-232 adaptor and configure the HexEngine TBR setting before proceeding. *Note, the baud rate into the ESD200 does not have to match the baud rate on the host PC bluetooth adaptor.*

Although not essential, if you have an RJ-232 adaptor lead, it is advised to plug this in during ESD200 configuration so that the progress and any configuration errors can be monitored. Connect the RJ-232 lead from the RJ11 port to a free serial port on your host PC, and start up your terminal software.

With the JP1 jumper in the 'B' position, switch on power to the *p.Brain-μ24*, wait until the unit has booted up, (approx 2 seconds), then press and hold the small tactile switch located under the power terminal CN3 for at least 2 seconds, then release. All going well your ESD200 will be configured in approximately 5 seconds. *If you are using the RJ-232 lead, you should see a configuration start and configuration OK message in your terminal screen.*

The bluetooth pass key or pin code is: 1138 *This is only true for version 1.2 and higher of the HexEngine, for versions below 1.2, please see the relative documentation.*

Once configuration is complete, your ESD200 should now be in discover mode, this means that you should be able to pair with your ESD200 using Windows bluetooth utility or similar. During the pairing procedure you will be asked for the pass key defined above. When pairing is complete, you should be able to connect you your ESD200 with the COM port assigned by your host operating system.

LED1

The blue LED next to the ESD200 is the connection LED. This should illuminate when a connection is made between the device and a host system. *Note I have noticed in some cases the LED does not light even when a connection is established, this seems to be determined by the host software initiating the connection!?*

p.Brain-HexEngine (V1.2) Configuration Guide

PS2 Gamepad Control

The HexEngine can have a Playstation PS2 style controller directly connected to the 8 channel I/O port. This gives a convenient way to make your hexapod into a remote controlled robot without the need for an intermediate processor.

Connection to the PS2 controller:

PS2 Gamepad Signal	p.Brain-ds24	p.Brain-SMB	p.Brain- μ 24
CLK	DIG4 (CN1 - 17)	CN19 - 15	CN2 - 2
ATT	DIG5 (CN1 - 18)	CN19 - 13	CN2 - 4
CMD	DIG6 (CN1 - 19)	CN19 - 11	CN2 - 6
DAT	DIG7 (CN1 - 20)	CN19 - 9	CN2 - 8
GROUND	N/A	CN19 - 16	CN2 - 3
+5V	N/A	CN17 - 9 (For 5V Power) CN17 - 8 (For 3.3V Power) **	CN2 - 5 (for 3.3V Power) **

**** Note:** All wired & wireless PS2 gamepads we have tested work fine 3.3V, but not all will work at 5V, therefore we suggest using 3.3V from CN17 to power the gamepad. If this does not work try the 5V output on CN17.

PS2 Connection Cable

To connect a PS2 gamepad to the p.Brain-SMB or p.Brain- μ 24, you will need the female end of a PS2 extension cable. The cable needs to be about 8 inches long, and requires the following 6 connections:

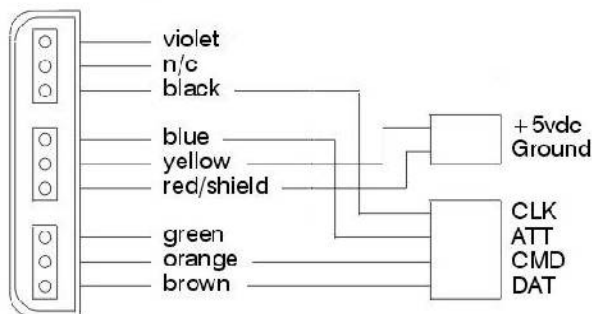

Note! Extension cable wire colours vary, so its best to use a continuity tester to determine the correct connections.

Once connected to the SMB/ μ 24, switch on the PS2 control mode within the HexEngine configuration screen by typing PS2=1, exit and save the configuration. Enter the "PS2 TEST" screen to check that your PS2 controller is connected, this screen should display the button and joystick of the controller.

p.Brain-HexEngine (V1.2) Configuration Guide

PS2 Control Functionality

PS2 Button	Function
Start	Power up / power down the hexapod
Triangle	Select tripod gait
Circle	Select ripple gait 3
Cross	Select ripple gait 2
Square	Select ripple gait 1
Select + Triangle	Increase leg transition speed
Select + Cross	Decrease leg transition speed
Select + Circle	Toggle full 3D balance gesture
Select + Square	Toggle Off-Road gait
Select + R1	Reset the hexapod legs to home position
Select + R2	Reset leg transition speed to configuration default
Left Thumb Up	Walk Forward
Left Thumb Down	Walk Backwards
Left Thumb Left	Turn Left
Left Thumb Right	Turn Right
Right 1 (Held Down)	Enable proportional walking: Forward/Backward = Right Stick Up/Down Turn = Right Stick Left/Right Crab = Left Stick Left/Right
Right 2 (Held Down)	Enable proportional body rotate/translate X Rotate = Right Stick Up/Down Y Rotate = Left Stick Left/Right Z Rotate = Right Stick Left/Right While holding (Left 2) X Translate = Right Stick Left/Right Y Translate = Right Stick Up/Down Z Translate = Left Stick Up/Down
Left 1 (Held Down)	Head Pan = Left Stick Left/Right Head Tilt = Left Stick Up/Down

Image of PS2 cable connected to HexEngine
CN19 & CN17 (Using 5V configuration)

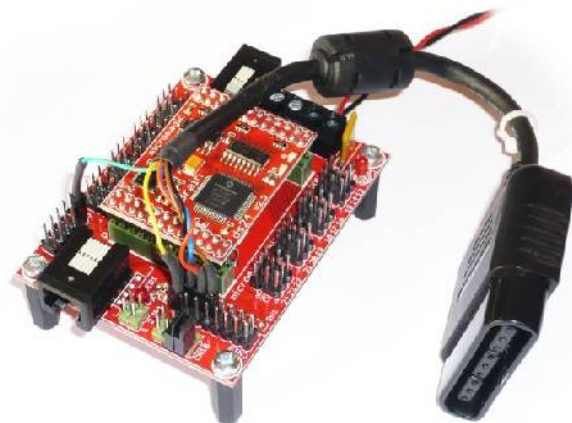

p.Brain-HexEngine (V1.2) Configuration Guide

Legal

Please read fully before purchasing any merchandise from micromagic systems ltd.

PRODUCTS

In no event shall micromagic systems be liable for any claim for incidental, consequential damages, or any injuries sustained due to the use of or improper use of products and / or kits purchased out of or in connection thereof with the manufacture, sale, delivery or use of any product in this catalogue or web site. All micromagic systems products purchased should NOT be used for medical, life-saving, life-support, or any applications that could cause injury, dangerous / hazardous situations or consequential damages resulting from the use of the mechanical, hardware or software products sold or represented by micromagic systems.

All products sold by micromagic systems are for Self Learning Experiences, and for Safe Entertainment.

Prices and Specifications

Note

Product specifications, prices listed and availability of items in our web site and in our printed catalogue are subject to change without notice. All prices shown in our web site and in our printed catalogue are believed accurate at time of publication, but subject to change without any notice. We will always advise you of the new price increase and seek your approval before processing any orders you place.

General Product Terms and Conditions

Call micromagic systems before returning any items.

PRODUCT RETURNS POLICY

All sales are final.

New products are warranted for 30 days. Any return for repair or replacement must be pre-authorized by micromagic systems and under no circumstance will returns be accepted unless so authorized. Return Products under warranty must be pre-approved by MMS and sent via certified mail, prepaid and insured, for your protection. (Please note we cannot refund shipping fees). All electronic kit sales are final. Due to the fact that components of the kit may be damaged during assembly we do not accept returns or refunds on any electronic kits

If you receive damaged merchandise, you must contact micromagic systems within 2 days of receipt of your original order. Specify clearly the reason for your refusal. We will exchange returned merchandise for same new merchandise, or for the item sterling amount within 7 days once we receive the returned damaged items from you. Proof of mailing is advised, as we cannot be held responsible for loss of the returned merchandise in mail transit. All return postage is non-refundable. The merchandise, including packing and wrapping material, being returned should be in the same condition as when you received them. Please contact us via e-mail at matt@micromagicsystems.com. Defective merchandise will be replaced (No cash will be refunded). We reserve the right to refuse to replace any merchandise, which our micromagic systems technicians determine to be damaged by the user, or through inappropriate use of that merchandise.

WARRANTY POLICY

We guarantee all products except electronic kits to be free of defects in workmanship and material for 30 days from the purchase, delivery date. We will repair or replace non-electronic kits (No cash will be refunded), at our option providing there is no evidence of customer misuse or alteration to that product item.

micromagic systems carries a limited 30 day warranty on most all items, some items carry an additional number of warranty days or special restrictions. If you want specific warranty information about a product contact micromagic systems to obtain that information.

We are not able to offer any refunds or accept returns for the following items and products: Electronic Kits.

CANCELLATION POLICY

Please be aware that if you cancel an order you may be responsible for restocking fees and / or shipping charges, including charges for return shipping. Cancelled orders are subject to a 25% or £10.00 minimum restocking fee. Orders cancelled within 24 hours of order placement will not be subject to restocking fees however this does not apply to orders with Express Shipping and Handling.